

P/N

SR-BASE 010

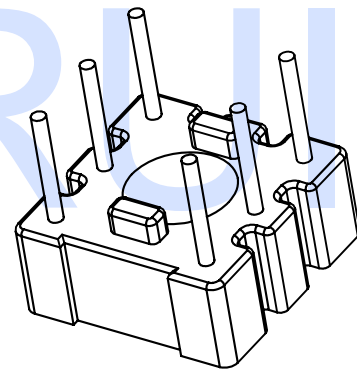
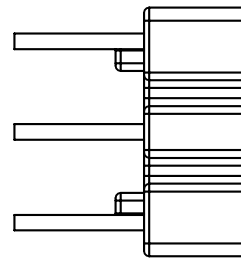
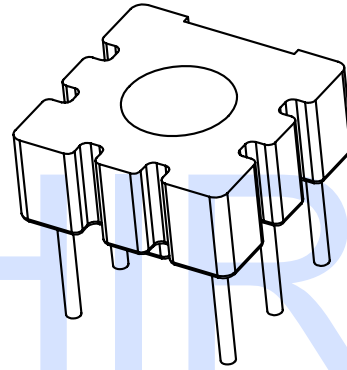
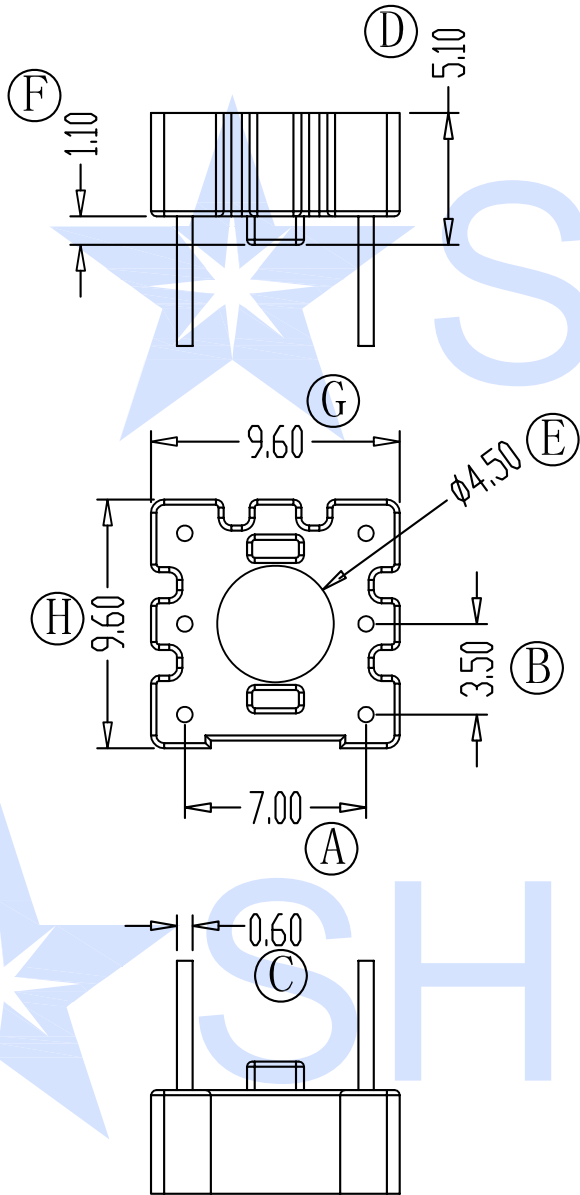

Hefei Shirui Electronic Technology Co., Ltd

TEL: (0086) 55165232650

sales@shiruitech.com

www.shiruitech.com

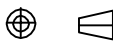
SR NO. SR-BASE 010	MATERIAL: PHENOLIC	UNIT: mm	TOLERANCE	DRN.	WILL H
MODEL NAME! BASE-(3+3P)	UL REC: UL 94V-0		0 L 4 ± 0.10	CHD.	IRINA LEE
	ANGLE: \pm° 		4 L 16 ± 0.20	ISSD.	JAMES HU
	SCALE 1:1		16 L 64 ± 0.30		
			PIN PITCH ± 0.05		